

Uniden®

OWNER'S MANUAL

TRU346



24
tru
.4GHZ
DIGITAL SPREAD SPECTRUM

Welcome

Congratulations on your purchase of the TRU 346 cordless telephone. This phone is designed for reliability, long life, and outstanding performance utilizing the latest in 2.4 GHz Spread Spectrum technology.

Note: Some illustrations in this manual may differ from the actual unit for explanation purposes.

Features

- 2.4 GHz Spread Spectrum Technology
- Caller ID and Call Waiting Caller ID
- 50 Number Caller ID Memory
- Advanced Caller ID with Call Waiting Options
- Lighted Keypad
- 3-Line, 16 Character Backlit Handset Display
- 20 Enhanced Memory Dial Locations
- 32 Digit Redial
- 3 Redial Memories
- Bilingual Language, option
- Flash
- Pause
- Pulse/Tone Dialing
- Page/Find
- 10 Day Standby Battery Life
- 6 Hour Talk Time
- Handset Earpiece and Ringer Volume Control
- Hearing Aid Compatible

Digital Spread Spectrum Technology utilizes a “wider frequency band” vs. a “single narrow band” used in standard digital transmissions. The 2.4 GHz frequency range was recently released to commercial communications. The result is a more secure conversation with the clarity of digital sound, extended range, and minimal interference from other cordless phones.

Random Code™ digital security automatically selects one of approx. 65,000 codes for the handset and base.

These features enhance your phone’s security and also prevents unauthorized calls as a result of your phone being activated by other equipment.

Uniden® is a registered trademark of Uniden America Corporation.

Random Code and AutoTalk are trademarks of Uniden America Corporation.



Contents

Welcome/Features	inside front cover	Erasing a stored name and phone number	26
Controls and Functions	2, 3	Paging	27
Getting Started		Caller ID Features	
Read this first	4	Caller ID	28
Step 1: Checking the package contents	5	When the telephone rings	30
Step 2: Setting up the base unit	6	Viewing the Caller ID Message list	31
Step 3: Preparing the battery pack	9	Deleting information from the Caller ID list	32
Adjusting the ringer and earpiece volume	11	Using the Caller ID list	34
Basics		Using "Caller ID on call waiting" service	36
Making a call	12	Call Waiting features	37
Receiving a call	14	Additional Information	
Redialing a call	15	Changing the digital security code	38
Traveling out-of-range	16	Beltclip installation	39
Telephone Features		Headset installation	39
Memory dialing		Note on power sources	40
Storing phone numbers and names	17	Maintenance	40
Steps for entering names and special characters	19	Troubleshooting	41
Making calls with memory dialing	21	General Information	43
Chain dialing	22	Technical Information	44
Editing a stored name and/or phone number	23	Index	46

Controls and Functions

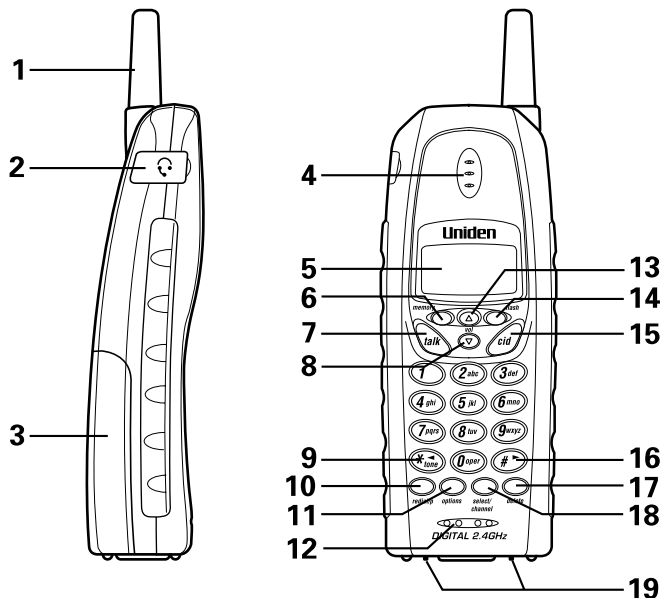

1. Handset antenna
2. Headset jack cover
3. Handset battery compartment
4. Handset earpiece
5. LCD display
6. Memory key
7. Talk key
8. Vol (Volume)/Cursor down ▼ key
9. */left cursor (◀)/tone key
10. Redial/p (Redial/Pause) key
11. Options key
12. Handset microphone
13. Vol (Volume)/Cursor up ▲ key
14. Flash key
15. Cid (Caller ID) key
16. #/right cursor (▶) key
17. Delete key
18. Select/Channel key
19. Handset charging contacts

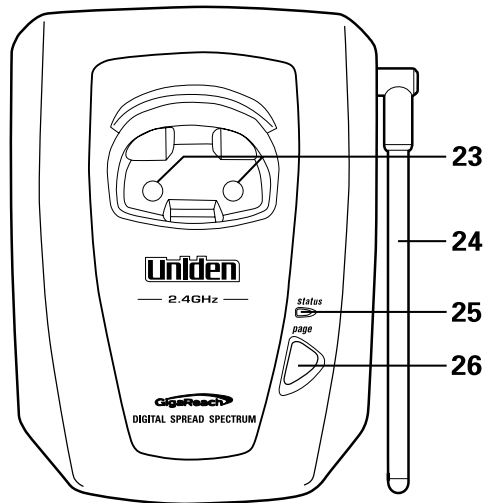
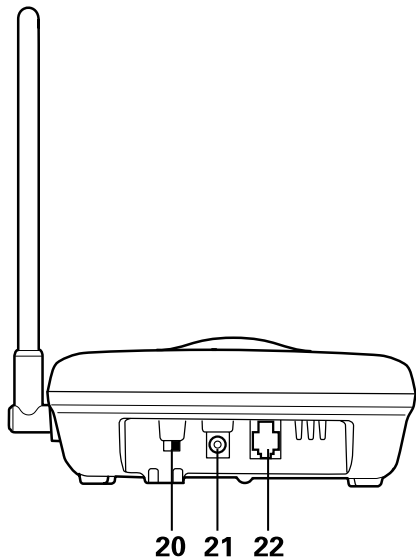

- 20. Pulse-Tone switch
- 21. DC power input
- 22. Phone jack
- 23. Base charging contacts
- 24. Base antenna
- 25. Status LED
- 26. Page key

Read This First

This cordless telephone must be set up before use. Follow these steps:

Step 1 (page 5)

Unpack and check the telephone and accessories.

Step 2 (page 6 to 8)

Next, choose the best location to set up the base unit.



Base

Step 3 (page 9 to 10)

Then, insert the battery pack into the handset. You must charge the battery pack for **15-20 hours before plugging into the phone line and using the phone.**



Handset

About the digital security code

This cordless telephone uses a digital security code to prevent unauthorized access to your base unit. This security code prevents other cordless handsets from making calls through your base unit. A random security code will be assigned automatically between your base unit and handset when you charge the battery pack for the first time.

If you want to reset the security code, see page 38.

Checking the Package Contents

Make sure you have received the following items in the package.

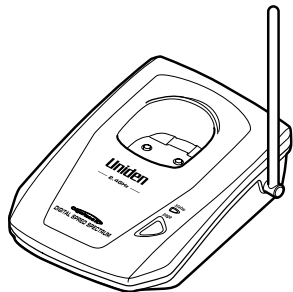

• Base unit



• Handset

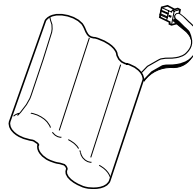

• Rechargeable battery

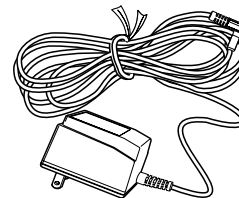

• AC adapter

- This Owner's Manual
- Quick Reference Guide
- Other Printed Materials



• Beltclip

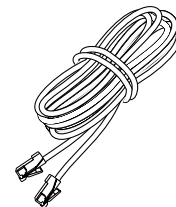

• Telephone cord

Uniden Parts Department

(800) 554-3988

Hours: M-F 7:00 AM to 5:00 PM CST.

We can also be reached on the web at www.uniden.com

Setting up the Base Unit

Do the following steps:

- Choose the best location
- Connect the base unit
- Choose the dialing mode

Choose the best location

Before choosing a location for your new phone, read the **INSTALLATION CONSIDERATIONS** included in the **PRECAUTIONS AND IMPORTANT SAFETY INSTRUCTIONS** brochure. Here are some important guidelines you should consider:

Avoid heat sources, such as radiators, air ducts, and sunlight

Avoid television sets and other electronic equipment

Choose a central location

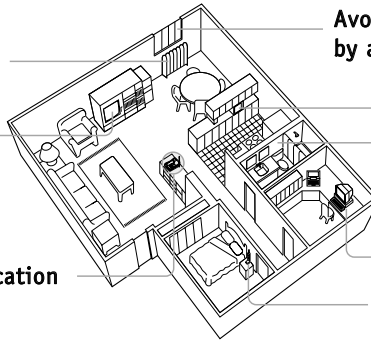

Avoid noise sources such as a window by a street with heavy traffic

Avoid microwave ovens

Avoid excessive moisture, extremely low temperatures, dust, mechanical vibration, or shock

Avoid personal computers

Avoid other cordless telephones

- After installing the battery pack in the handset, charge your handset at least **15-20 hours before using the phone**. Once the handset battery pack is fully charged, connect the telephone line cord to the base and telephone wall outlet.
- The location should be close to both a phone jack and a continuous power outlet which is not switchable.
- Keep the base and handset away from sources of electrical noise such as motors and fluorescent lighting.
- Be sure there is sufficient space to raise the base antenna to a vertical position.

Connect the base unit

- 1 Connect the telephone line cord to the **TEL LINE** jack and to a telephone outlet.
- 2 Connect the AC adapter to the **DC IN 9V** jack and to a standard 120V AC wall outlet.
- 3 Set the base unit on a desk or tabletop and place the handset on the base unit as shown. Then raise the antenna to a vertical position.

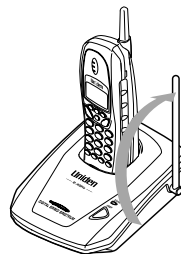
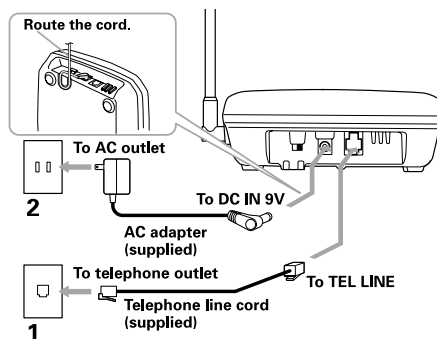

Modular



Connect the AC adapter to a continuous power supply.



If your telephone outlet isn't modular, contact your telephone company for assistance.



- Place the power cord so it does not create a trip hazard or where it could become chafed and create a fire or electrical hazard.
- Use only the supplied AD-312 AC adapter. Do not use any other AC adapter.
- Place the base unit close to the AC outlet so that you can unplug the AC adapter easily.

Choose the dialing mode

Depending on your dialing system, set the **PULSE-TONE** switch as follows:

If your dialing system is	Set the switch to
Tone	<i>TONE</i>
Pulse	<i>PULSE</i>

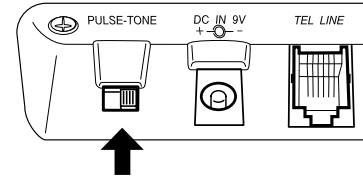

If you aren't sure of your dialing system

Make a trial call with the PULSE-TONE switch set to ***TONE***.

If the call connects, leave the switch as is; otherwise, set to ***PULSE***.

Preparing the Battery Pack

Charge the battery pack for at least 15-20 hours before you start using your phone.

- 1 Press in on the battery cover release and slide the cover down until it comes off.
- 2 Connect the battery pack connector with the correct polarity (black and red wires), then insert the battery pack into the battery compartment.
- 3 Securely close the battery compartment cover by sliding it up until it snaps into place.
- 4 Place the handset on the base as shown.
- 5 Make sure that the **status** LED lights. If the LED doesn't light, check to see that the AC adapter is plugged in and that the handset makes good contact with the base charging contacts.

note

Use only the Uniden Battery (BT-800) supplied with your phone. Replacement batteries are also available through the Uniden Parts Department. (see page 5)

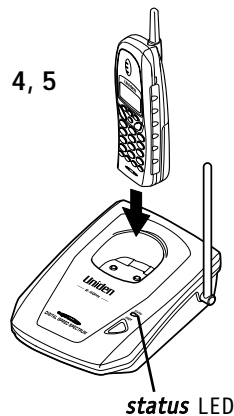
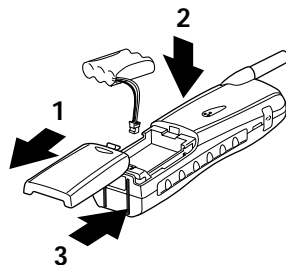

The plastic connectors will fit together only one way. Make sure the battery's connector is properly aligned.



- Even when the battery pack is not being used, it will gradually discharge over a long period of time. For optimum performance, be sure to return the handset to the base unit after each telephone call.
- If you must replace the battery pack during a telephone call, complete the replacement within 30 seconds, and you can return to the original call.

Battery use time (per charge)

From fully charged

- Six hours continuous use
- Ten days when the handset is in the standby mode

When the battery charge becomes low

When the battery pack is very low and needs to be charged, the phone is programmed to eliminate functions in order to save power. If the phone is not in use, "Low Battery" flashes and none of the keys will operate. If the phone is in use, "Low Battery" flashes and the handset beeps. Complete your conversation as quickly as possible and return the handset to the base unit for charging.

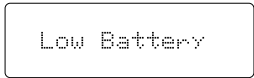

The last number dialed in the redial memory is retained for up to 2 minutes while you replace the battery pack.

Cleaning the battery contacts

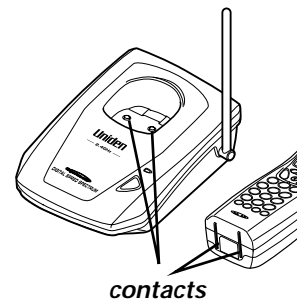

To maintain a good charge, it is important to clean the battery contacts on the handset and base unit with a dry cloth or a pencil eraser about once a month.

Do not use any liquids or solvents.





Adjusting the Ringer and Earpiece Volume

Handset ringer tone and volume

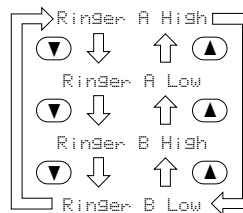
Press  or  in Standby mode to select one of four ringer tone and volume combinations.





Earpiece volume

Pressing  or  during a call will change the earpiece volume of the handset. This setting will remain in effect after the telephone call has ended.



Volume Maximum  Volume High  Volume Medium  Volume Low 



When you press  in Maximum mode or  in Low mode, an error tone sounds.

Ringer off

During the standby mode or tone/volume setting, press and hold  until the phone beeps and "Ringer Off" appears.

To turn the ringer back on, simply press  or . "Ringer A High" appears.

Ringer Off



- Press **(delete)** if you enter a wrong number in step 1. To delete all the numbers that you have entered, press and hold **(delete)** until the display clears.
- You must press a key within 20 seconds or the phone will return to standby.

Making a Call

Dialing from standby



1 Enter the phone number.
(Up to 32 digits.)
Example: Enter 8002971023

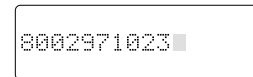

2 Press **(talk)**.
“Talk” flashes on the display.
Then the volume setting is displayed.

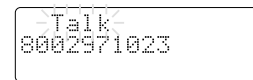

Example: • Volume level Volume Medium

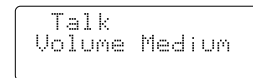

• Volume level Volume Medium
and Ringer Off.

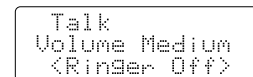

3 The number is dialed.
After about 5 seconds, the call-time
display appears.

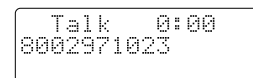

4 To hang up, press **(talk)** or place the
handset on the base. The call-time will
be displayed for about 5 seconds.

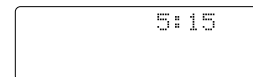

Other Operations

To	Do this
To adjust the earpiece volume	Press ▲ or ▼ during a call.
To temporarily switch to tone dial (when the base is set to pulse mode)	Press *tone . The following numbers will be sent as tone dialing.
To enter a pause within the dialing sequence	Press redial/p . "P" appears in the display which represents a pause.
To improve the reception	Press select/channel during a call. "Scanning" appears on the display. If the operation fails, the error tone sounds.

Dialing from talk mode

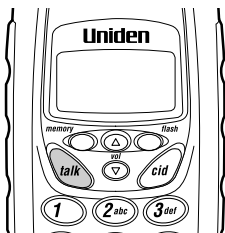

- 1 Press **talk**.

"Talk" flashes on the display.

Then the volume setting is displayed.

Example: Volume level Volume Medium.



If you set the ringer to off,

"<Ringer Off>" appears on the display.

After about 5 seconds, the call-time display appears.

- 2 Enter the phone number.

Example: Enter 8002971023

The number is dialed.

- 3 To hang up, press **talk** or place the handset on the base.

The call-time will be displayed for about 5 seconds.

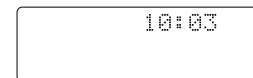
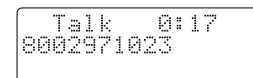
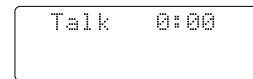
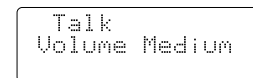
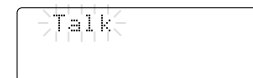



If you receive a Caller ID, the received Caller ID information appears.

Receiving a Call

From the handset

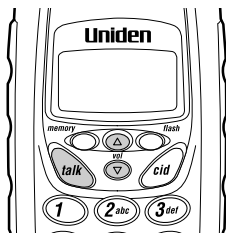

- 1 The phone rings. "Incoming Call" appears on the display.
- 2 Press **(talk)**. "Talk" and volume setting appear on the display.

Incoming Call

Talk 0:00
Volume Medium



If you set the ringer to off, "<Ringer Off>" appears on the display.

- 3 Talk with the caller.
- 4 To hang up, press **(talk)** or place the handset on the base.
The call time will be displayed for about 5 seconds.

Talk 0:02

115:35

AutoTalk when ringing

When the AutoTalk setting is on and there is an incoming call, simply lift the handset from the base unit to answer the phone. See "Setting Caller ID options" on page 28 for more details.

Any key answer when ringing

When the AutoTalk setting is on and the handset is off the base, press any handset key to answer the incoming call.

Call Waiting

Note: You must subscribe to Call Waiting service to use this feature.

When a call is received during a telephone call already in progress, press **(flash)** to switch to the new call. If you also subscribe to Caller ID on Call Waiting, you will see the name and number of the caller in call waiting. (See page 36.)

Redialing a Call

The last three phone numbers dialed can be quickly redialed.

Redial from standby

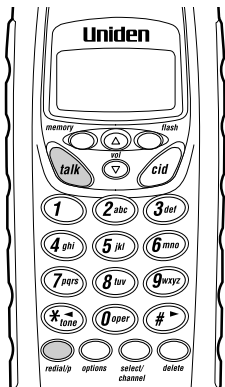

1 Press **redial/p**.

The phone number that was last dialed appears on the display.

2 Press **redial/p** again.

Each press of **redial/p** will display one of the last three numbers dialed.

Most recent

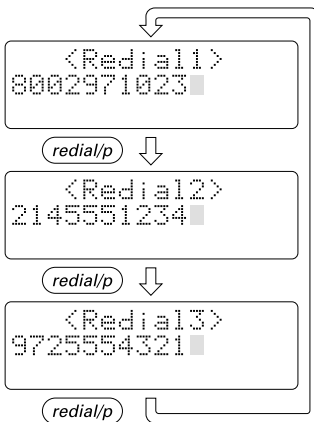

3 Press **talk**. The number will be dialed.



- If the number exceeds 32 digits, only the first 32 digits are retained for redialing.
- Press and hold **delete** to delete the displayed redial number.

Redial from talk mode

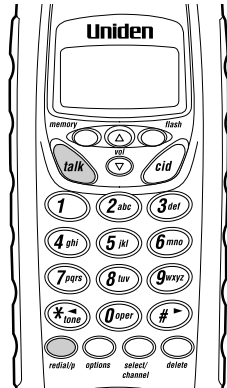

- 1 Press **talk**.
“Talk” and the volume setting appear on the display.



note If you set the ringer to off, “<Ringer Off>” appears on the display.

- 2 Press **redial/p**.
The last number dialed will be displayed and redialed.
- 3 To hang up, press **talk** or place the handset on the base. The call-time will be displayed for about 5 seconds.

note Only the last number dialed can be accessed after **talk** has been pressed.

Traveling Out-of-Range

During a call, as you begin to move your handset too far from your base unit, noise increases. If you pass the range limits of the base unit, your call will terminate within 30 seconds.

Storing Phone Numbers and Names

Memory Dialing allows you to dial a number using just a few key strokes. You can store up to 20 phone numbers in the memory.

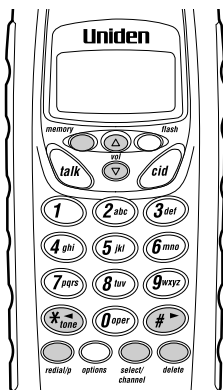

1 Press and hold **memory** until “Memory Store” is displayed.

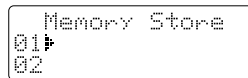

2 Press **▲** and **▼** or enter a two-digit number (01 - 20) to select the memory location where you would like to store the number.

3 Press **select/channel**.

The following screen appears and a cursor flashes indicating that the display is ready for the name to be entered.

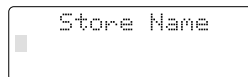

If this screen appears, the selected memory location is already stored. Then, you must either change the entry in this location, clear the location, or select “Go Back” to choose another location.

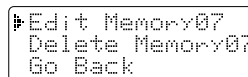

- 4 To enter a name (up to 13 characters), use the number keys.
- See the “Steps for entering names and special characters”. (See pages 19-20)
 - Use **#** and ***tone** to move the cursor to the desired location.
 - Use **delete** to delete characters as needed.
 - Press and hold **delete** to delete all the characters.
 - If a name is not required, go to step 5.

5 Press **(select/channel)**.

“Store Number” is displayed. The cursor flashes indicating that the display is ready for the number to be entered.

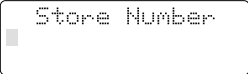

Store Number

6 Use the number keypad to enter the phone number. The phone number cannot exceed 20 digits.

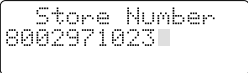

Store Number
0002971023

- Use **(redial/p)** to enter a pause in the dialing sequence. The display shows a “P”. Each pause counts as one digit and represents a two second delay in time between digits.



The pause feature is useful for long distance calling, credit card dialing, or sequences that require a pause between digits.

- Use **(delete)** to delete digits as needed.

7 Press **(select/channel)**.

The handset beeps and displays the confirmation screen. Memory storage is complete.

For example, if you store a name and number into memory location number 07, the display shows “Memory07 Stored”.

After about 2 seconds, “Memory Store” is displayed.

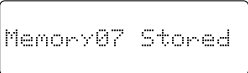

Memory07 Stored



Memory Store
07 UNIDEN CORP
08

8 Press **(memory)** to return to standby mode.

Steps for Entering Names and Special Characters

Refer to the letters on the number keys to select the desired characters. With each press of a numeric key, the displayed character appears in the following order: Upper case letters first, lower case letters next and finally the number corresponding to the key.

	Number of times key is pressed								
keys	1	2	3	4	5	6	7	8	9
1	1								
2abc	A	B	C	a	b	c	2		
3def	D	E	F	d	e	f	3		
4ghi	G	H	I	g	h	i	4		
5jkl	J	K	L	j	k	l	5		
6mno	M	N	O	m	n	o	6		
7pqrs	P	Q	R	S	P	q	r	s	7
8tuv	T	U	V	t	u	v	8		
9wxyz	W	X	Y	Z	w	x	y	z	9
0	*	#	-	&	()	(blank)	0	

If you make a mistake while entering a name

Use ***tone** or **#** to move the cursor to the incorrect character. Press **delete** to erase the wrong character, then enter the correct character. To delete all characters, press and hold **delete**.

For example, to enter **Uniden**:

- 1 Pick up the handset and press and hold *memory*.
- 2 Enter a number or press *▲*, *▼* to select a memory location number.
- 3 Press *select/channel*.
- 4 Press *8* twice.
- 5 Press *6* five times.
- 6 Press *4* six times.
- 7 Press *3* four times, then press *#▶* to move the cursor to the right.



If the next character uses the same number key, you must press *#▶* to move the cursor over. Otherwise the next time you press the number key, it changes the character that was previously set.

- 8 Press *3* five times.
- 9 Press *6* five times.
- 10 When finished, Press *select/channel*.

To continue to store the telephone number, proceed to step 6 on page 18.

Making Calls with Memory Dialing

Memory dialing from standby



- 1 Press **memory**.
The handset displays your programmed memory locations.
- 2 Press **▲** and **▼** or enter a two-digit number (01 - 20) to select the memory location you would like to dial.
- 3 Press **talk**. "Talk" and the volume setting appear on the display. Then the displayed number is dialed.

```
01▶UNIDEN CORP
02 JOHN DOE
03 MOM AND DAD
```

```
-Talk-
0123456789012
```



- If you press **select/channel** before **talk**, you can confirm the name and number stored in the selected memory location. To exit this mode, press and hold **delete**. The handset returns to standby.
- To exit the memory function without dialing, press **memory**. The handset returns to standby.

Display a Programmed Number

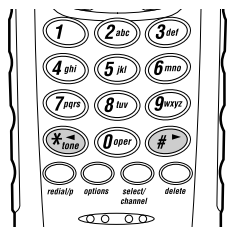

Use **#▶** and ***tone▶** to toggle between the names display and the numbers display.

Program name	↔▶	Program number
01 UNIDEN CORP	↔▶	01 8002971023
02 JOHN DOE	↔▶	02 5452930
03▶MOM AND DAD	↔▶	03▶8175551212



When the stored phone number has 14 or more digits, "▶" is displayed next to the 12th digit. Press **#▶** to see the extra digits and ***tone▶** to return.

```
05 012345678901
06▶011813554329+
07
```





If you select a memory location that does not have a stored number, the handset will beep rapidly and the phone will not dial.

Memory dialing from talk mode

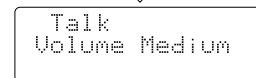
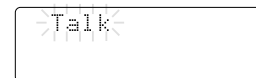

- 1 Press **talk** .
"Talk" and the volume setting appear on the display.



-  If you set the ringer to off, "**<Ringer Off>**" appears on the display.

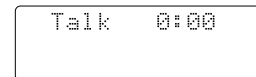

- 2 press **memory** .

- 3 Enter a two-digit number (01 - 20) to select the memory location of the desired phone number.
The selected phone number is displayed.
Then the number is dialed.

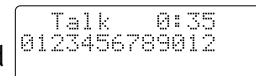

Chain Dialing

On certain occasions after dialing a number, you may be requested to enter an access code, such as your account number. You can enter this number into a memory location for later use by doing the following:

- 1 Store the access code into one of the memory locations (01-20) following the steps on page 17.
- 2 Dial the party or service main number.
- 3 When you need to enter the special number, press **memory** followed by the memory location (01-20).

Editing a Stored Name and/or Phone Number

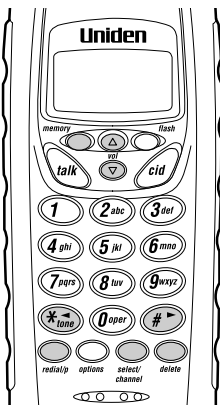

1 Press and hold memory until “Memory Store” is displayed.

```
Memory Store
01 UNIDEN CORP
02 JOHN DOE
```

2 Press ▲ and ▼ or enter a two-digit number (01 - 20) to select the memory location you would like to edit.

3 Press select/channel.

The following screen appears with the memory location number that you have selected in the display.

```
Edit Memory01
Delete Memory01
Go Back
```

4 Press ▲ or ▼ to select “Edit Memory”, then press select/channel.

The following screen appears. The cursor flashes indicating that the display is ready for the name to be edited. When a name has not been stored, the cursor appears at the beginning of the second line.

```
Store Name
UNIDEN CORP
```

5 Press number keypad, #, *tone, or delete to edit the name. (See page 17.) To edit only the phone number, skip this step.

6 Press **(select/channel)**.

The following screens appears.

The cursor flashes indicating that the display is ready for the number to be edited.

```
Store Number
0002971023
```

7 Use the number keypad, **(redial/p)** or **(delete)** to edit the phone number.

The phone number cannot exceed 20 digits. (See page 18.)

If you don't want to change the phone number, skip this step.

8 Press **(select/channel)**. The handset beeps and displays the confirmation screen. The memory storage is complete.

For example, if you store a name and number into memory location number 01, the display shows

"Memory01 Stored".

After about 2 seconds,

"Memory Store" is displayed.

```
Memory01 Stored
```

```
Memory Store
01 UNIDEN CORP
02 JOHN DOE
```

9 Press **(memory)** to return to standby mode.

Display a Programmed Number

Use **#>** and ***tone>** to toggle between the names display and the numbers display.

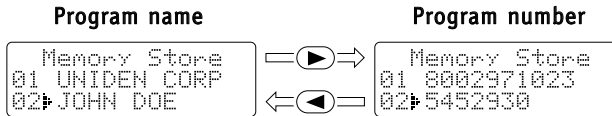

- When the stored phone number has 14 or more digits, “**#>**” is displayed next to the 12th digit. Press **#>** to see the extra digits and ***tone>** to return.

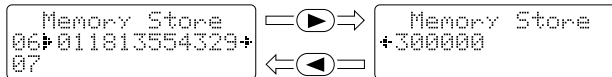

Erasing a Stored Name and Phone Number

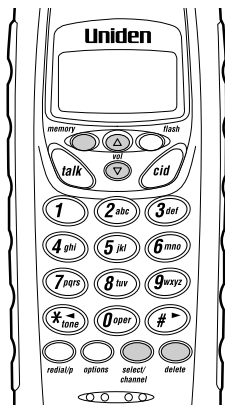

- 1 Press and hold **memory** until "Memory Store" is displayed.
- 2 Press **▲** and **▼** or enter a two-digit number (01 - 20) to select the memory location you would like to erase.
- 3 Press **select/channel**.
The following screen appears with the memory location number that you have selected in the display.
- 4 Press **▼** to move the pointer down to the "Delete Memory" command line.
- 5 Press **select/channel**. The following confirmation screen appears.
- 6 Press **▲** to move the pointer to "Yes".
- 7 Press **select/channel** or **delete**.
There is a confirmation tone and the entry is deleted. The following screen appears.
- 8 After a few seconds the display returns to the "Memory Store" screen. You may select another number to delete (return to step 2) or press **memory** to return to standby.

```
Memory Store
01 UNIDEN CORP
02 JOHN DOE
```

```
Edit Memory02
Delete Memory02
Go Back
```

```
Edit Memory02
Delete Memory02
Go Back
```

```
Delete Memory02?
Yes
No
```

```
Memory02 Deleted
```

```
Memory Store
02
03 MOM AND DAD
```

Paging

To locate the handset

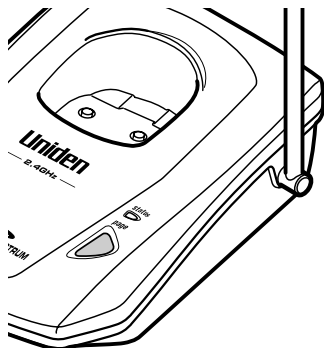

- 1 Press **page** on the base.
- 2 The handset beeps for 60 seconds.
The following screen appears:

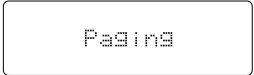

- 3 Press any key on the handset or **page** on the base, or return the handset to the base to end the page.



When an incoming call is received during paging, paging is canceled and the telephone is switched to the incoming call.



- You must subscribe to Caller ID on Call Waiting in order to use this feature.
- The Call Waiting options are a separate service available through your phone company.
- If your calling area requires 10-digit dialing, do not program this option.

Caller ID

You must subscribe to Caller ID service to use this feature.

When the telephone rings, the Caller ID feature allows you to view the caller's name and phone number on the display before you answer the phone.

The handset displays the phone number of the incoming call, the name, time, and the number of calls. Additionally, you can dial the displayed number and store the information for memory dialing.

Setting Caller ID options/Language

There are three Caller ID setup options available: AutoTalk, CIDCW (Caller ID on Call Waiting) and Area Code.

AutoTalk allows you to answer the phone without pressing **talk**. If the phone rings when AutoTalk is on, simply remove the handset from the base and the phone automatically answers the call. Or, if the handset is not on the base, press any key to answer the call. If the phone rings when AutoTalk is off, you must press **talk** to answer the call.

Caller ID on Call Waiting (CIDCW) performs the same as regular Caller ID on a call waiting number. Call Waiting options allow you to handle call waiting calls in seven different ways. (See page 37.)

If you enter a 3-digit area code number in the **Area Code** option, your local area code does not appear in Caller ID messages. When reviewing or receiving Caller ID messages, you will see only the local 7-digit number. For calls received from outside your local area code, you will see a full 10-digit number.

Language option can be used to choose the language of your display. You can select either English or French.

To change your Caller ID options/Language:

- 1 When the phone is in standby mode, press **options**.
The following screen appears.

```

1▶ Auto Talk:Off
2 CIDCW      :On
3 Area Code:
  
```

- 2 Use **▲**, **▼**, or a number key (1-4) to move the pointer to the selection that you would like to change.

Press **select/channel** to toggle between "On" and "Off" for "Auto Talk". For "CIDCW", choose "On", "Off", or "Opt", depending upon the type of service to which you subscribe.

- 3 When you wish to enter the Area Code, press **▼** or the number key **3** to move the pointer to "Area Code". Then press **select/channel** and enter the 3 digit area code by using the number keypad **0-9**. After entering the area code, press **select/channel**.

- 4 To set up the language of your display, press **▼** or the number key **4** to move the pointer to "Language".
Press **select/channel** to select "Eng"(English) or "Fr"(French).

```

2 CIDCW      :On
3 Area Code:
4▶ Language :Eng
  
```

- 5 After you have made your selections, press **options** and return the handset to the base.



- If you answer a call before the Caller ID message is received (Example: before the second ring), the Caller ID message will not appear.

- When the call is received via a telephone company that does not offer Caller ID service, the caller's phone number and name do not appear. (This includes international calls.)

- When the call is via a private branch exchange (PBX), the caller's phone number and name may not appear.

When the Telephone Rings

- 1 When the Caller ID message is received, the display shows the caller's phone number. The incoming call information is stored in the Caller ID record. If the Caller ID service includes the caller's name, the caller's name appears on the display (up to 15 letters).

Caller's name — Incoming Call
 UNIDEN CORP
 Caller's phone number — 800-297-1023

Here are some typical displays:

When the phone number and name data are received

```
Incoming Call
UNIDEN CORP
800-297-1023
```

When a private name is received

```
Incoming Call
Private Name
800-297-1023
```

When an unknown name is received

```
Incoming Call
Unknown Name
800-297-1023
```

When invalid data is received

```
Incoming Call
Incomplete Data
```

When a private number is received

```
Incoming Call
UNIDEN CORP
Private Number
```

When an unknown number is received

```
Incoming Call
UNIDEN CORP
Unknown Number
```



When the ringer is set to off, "<Ringer Off>" appears instead of "Incoming Call".

- 2 When you pick up the phone, the display changes to "Talk". (See page 14.)



Data errors appear as "■".

```
Incoming Call
UNI■EN CORP
800-2■■-1023
```

Viewing the Caller ID Message List

The Caller ID list stores information for up to 50 incoming calls - even unanswered calls.

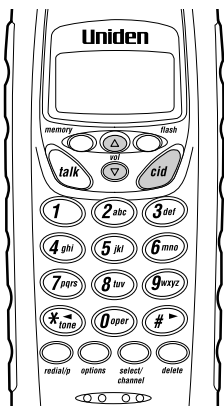

- 1 Press **(cid)**.
The summary screen appears.
The screen shows the number of new messages and total messages.
- 2 Press **(down arrow)** to display the latest Caller ID message.
- 3 Press **(down arrow)** to see the next message, or press **(up arrow)** to see previous message.
- 4 Press **(cid)** to return to standby.

```
New :01
Total:02
```

```
5/17 12:30PM 03
UNIDEN CORP
800-297-1023
```



- In Caller ID operation, if no key is pressed within 20 seconds, an error tone sounds and the telephone returns to the standby mode.
- If a call comes in via a telephone system that does not offer Caller ID service, no information is stored.
- Each message can be up to 15 characters for the phone number and the name.



- If you get an incoming call or page, the deleting operation is canceled. The telephone is set to receive the incoming call or page.
- In Caller ID operation, if no key is pressed within 20 seconds, an error tone sounds and the telephone returns to the standby mode.

Deleting Information from the Caller ID List

The TRU 346 stores up to 50 messages. If the phone receives the 51st message, the oldest one in the list is automatically deleted. Caller ID data can also be deleted manually.

Deleting a Caller ID message

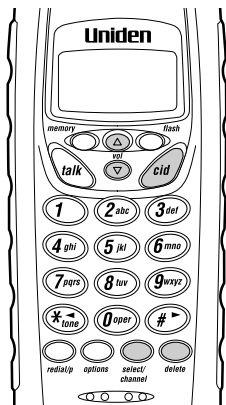

- 1 Press **cid** .
Display the message to be deleted from the Caller ID list by pressing **▲** or **▼** .
- 2 Press **delete** .
- 3 Press **▲** or **▼** to select "Yes" or "No" .
- 4 Press **select/channel** or **delete** .

```
5/17 12:30PM 03  
UNIDEN CORP  
800-297-1023
```

```
Delete Message?  
▶ Yes  
No
```

When the pointer is at "Yes" :

A tone sounds and the Caller ID message is deleted. The next Caller ID message is then displayed.

When the pointer is at "No" :

The display returns to the Caller ID display.

Deleting all Caller ID names/numbers

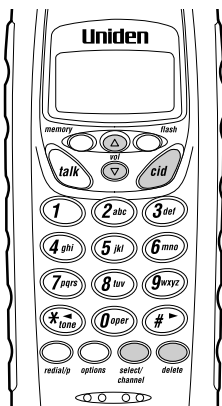

- 1 Press **cid** .
- 2 Press **delete** .
- 3 Press **▲** or **▼** to select "Yes" or "No" .
- 4 Press **select/channel** or **delete** .

When the pointer is at "Yes" :
A tone sounds and all stored Caller ID messages are deleted.

When the pointer is at "No" :
The display returns to the summary screen.

```
New :01
Total:02
```

```
Delete All?
Yes
No
```

```
Total:00
```

```
New :01
Total:02
```



If you get an incoming call or page, the deleting operation is canceled and the telephone is set to receive the incoming call or page.



- You cannot make a call from the Caller ID list if your TRU 346 is connected to a private branch exchange (PBX).
- When a long distance call has been set, "1" appears in the display.
- In Caller ID operation, if no key is pressed within 20 seconds, an error tone sounds and the telephone returns to the standby mode.

Using the Caller ID List

Calling a party from the Caller ID list

You can place a call from the Caller ID list. The TRU 346 stores up to 50 messages.

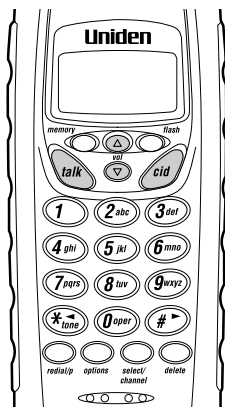

- 1 Press **(cid)**.
Select the phone number that you want to dial by pressing **(▲)** or **(▼)**.
- 2 Press **(talk)**.
The displayed phone number will be dialed automatically.

```
5/17 12:30PM 03  
UNIDEN CORP  
800-297-1023
```

```
Talk  
8002971023
```

Long Distance call and Area Code setting

Pressing **(1)** while the incoming call information is displayed (in step 1) will set or cancel a Long Distance call. Pressing **(3)** will set or cancel the area code setting.

Dial edit

You can edit the phone number of the Caller ID data when you press **(select/channel)** after step 1.

Storing Caller ID messages in Memory dialing

The phone number of the party on the Caller ID list can be stored in memory dialing.

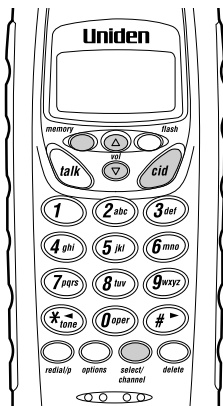

- 1 Press **(cid)**.
Select the phone number to be stored from the Caller ID list by pressing **(▲)** or **(▼)**.
- 2 Press **(memory)**.
- 3 Press **(▲)** and **(▼)** or enter a two-digit number (01 - 20) to select the memory location.
- 4 Press **(select/channel)**.
A confirmation tone will sound.
The number is stored in memory, and the display returns to the Caller ID list.

```
5/17 12:30PM 03
UNIDEN CORP
800-297-1023
```

```
Select Location
01 UNIDEN CORP
02 JONE DOE
```

```
5/17 12:30PM 03
UNIDEN CORP
800-297-1023
```



- You can not store a Caller ID message if no phone number appears in the message.
- If there is an incoming call or page, memory storage is canceled and the telephone is set to receive the incoming call or page.

Long Distance call and Area Code setting

When you need to store Long Distance call prefix "1" and area code, edit the number at step 1. Press **(1)** for Long Distance call and **(3)** for area code setting.



If a message has already been stored in the selected memory number location, a confirmation screen is displayed. Press **(▲)** to select "Yes". Press **(select/channel)** to overwrite. The display returns to the Caller ID list.

```
Replace Memory?
Yes
No
```

Using “Caller ID on Call Waiting” Service

“Caller ID” and “Call Waiting” are separate services. CIDCW (Caller ID on Call Waiting) performs the same as regular Caller ID on a call waiting number. You must subscribe to the “Caller ID on Call Waiting (CIDCW) services” before you can use the following features. The “Call Waiting” service can also be used independently. Please contact your local telephone company for details.

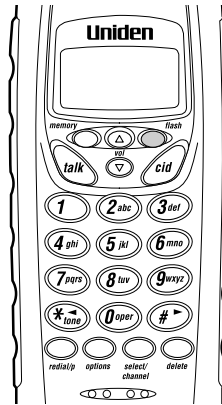

- 1 When a new incoming call is received during your current telephone call, the phone number and the name of the caller are displayed.
- 2 Press **flash**.
You will be able to talk with the second caller. The first caller will be put on hold.
- 3 To return to the first caller, press **flash** again.

```
Talk 10:30
UNIDEN CORP
800-297-1023
```



When CIDCW is set to **Off** in the Caller ID options (see page 29), you can press the **options** key after receiving a call waiting call and view a list of ways to handle the new call. Choose an option using the **▲** and **▼** keys or a number key (1-7), and press **select/channel** to activate.

Call Waiting Features

Your TRU 346 gives you new options for call waiting. At the touch of a button, you can ask the caller to hold, send them to your voice mail service, or conference them into your current call. You may be required to subscribe to a voice mail service, call waiting, and call waiting options to use these features. Not all features are available in all areas. Check with your local telephone company for details.

Selecting an Option

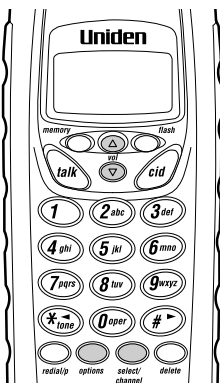

- 1 When you receive a call waiting call, press **(options)** for a list of options.
- 2 Press **(▲)** and **(▼)** keys or a number key (1-7) to select an option.
- 3 Press **(select/channel)** .
A confirmation screen will appear.

```

1 Ask to Hold
2 Tell Busy
3 Take Message
  
```



You can also answer a call waiting call immediately by pressing the **(flash)** key. The first caller will be placed on hold. To return to the original caller, press **(flash)** again.

Your TRU 346 is pre-programmed with seven call waiting options. You may select to ask the calling party to **hold**, send them a **busy** message, **forward** them to your voice mail service or **conference** them into the current call. You may also select to **answer and drop** the first caller or, at any time, choose to **drop the first** or **drop the last** caller.

Check with your local telephone company for a full list of options.



If the handset battery pack is completely discharged or the battery pack is removed, the digital security code will be lost. If this happens, a new security code is set automatically next time the battery pack is charged.

Changing the Digital Security Code

The digital security code is an identification code used to connect the handset and the base unit. Normally, setting the code is not necessary. The first time you charge your handset, the security code is automatically set. (See page 4.)

In the rare situation that you suspect another cordless telephone is using the same security code, you can change the code.

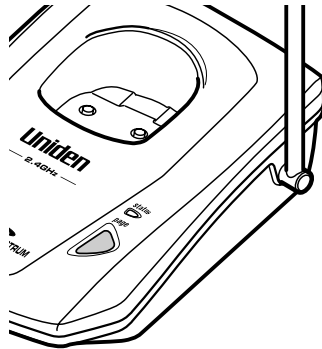

- 1 Remove the handset from the base unit. Press and hold **page**.
- 2 While the handset is emitting the paging sound, replace the handset on the base unit. The paging tone stops. Leave the handset on the base for more than 3 seconds. A random, new security code is set.

Beltclip Installation

To attach the beltclip

Insert the beltclip into the holes on each side of the handset. Press down until it clicks.

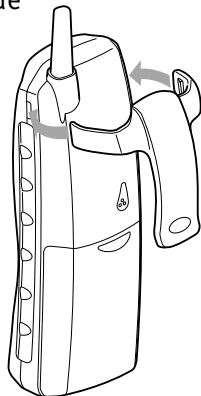

To remove the beltclip

Pull both sides of the beltclip to release the tabs from the holes.

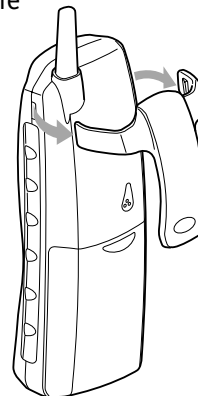

Headset Installation

Your phone may be used with an optional headset, the Uniden HS910. To use this feature, simply plug the headset plug into the headset jack. Your phone is ready for hands-free conversation. (Headsets may be purchased by calling the Uniden Parts Department or visiting the website. See page 5)

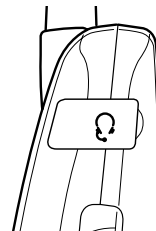

Note on Power Sources

Battery replacement and handling

When the operating time becomes short, even after a battery is recharged, please replace the battery.

With normal usage, your battery should last about one year.

Please contact your place of purchase or the Uniden Parts Department for a replacement battery. (See page 5)

Power Failure

During the period that the power is off, you will not be able to make or receive calls with the telephone.

RECYCLING NICKEL-CADMIUM BATTERIES



Nickel-cadmium cells are used in the battery pack. Please take your used nickel-cadmium battery packs to a store that recycles nickel-cadmium batteries.

Caution

- Use the specified battery pack.
- Do not remove the battery from the handset to charge it.
- Never throw the battery into a fire, disassemble it, or heat it.
- Do not remove or damage the battery casing.

Maintenance

When slightly dirty

Wipe with a soft, dry cloth.

When very dirty

Wipe with a soft cloth that has been dampened with diluted, neutral detergent. Dry with a dry cloth.

When the charging terminals become dirty

Wipe with a dry cloth or a pencil eraser, if necessary.

Caution

Do not use paint thinner, benzene, alcohol, or other chemical products. Doing so may discolor the surface of the telephone and damage the finish.

Troubleshooting

If your phone is not performing to your expectations, please try these simple steps first.

Symptom	Suggestion
The <i>status</i> LED won't light when the handset is placed in the base unit.	<ul style="list-style-type: none">• Make sure the AC adapter is plugged into the base unit and wall outlet.• Make sure the handset is properly seated in the base unit.• Make sure the charging contacts on the handset and base unit are clean.
The audio sounds weak and/or scratchy.	<ul style="list-style-type: none">• Press <i>(select/channel)</i> during a call to help eliminate background noise.• Make sure that the base unit antenna is in a vertical position.• Move the handset and or base unit to a different location away from metal objects or appliances and try again.• Make sure that you are not too far from the base.
Can't make or receive calls.	<ul style="list-style-type: none">• Check both ends of the base unit telephone line cord.• Make sure the AC adapter is plugged into the base unit and wall outlet.• Disconnect the AC adapter for a few minutes, then reconnect it.• Reset the digital security code (See page 38).• Make sure <i>(talk)</i> is pressed.

Symptom	Suggestion
The handset doesn't ring or receive a page.	<ul style="list-style-type: none"> • The battery pack may be weak. Charge the battery on the base unit for more than 15 hours. • The handset may be too far away from the base unit. • Place the base unit away from appliances or metal objects. • Reset the digital security code (See page 38).
The Caller ID does not display.	<ul style="list-style-type: none"> • The handset was picked up before the second ring. • The call was placed through a switch board. • Call your local telephone company to verify your Caller ID service is current. • Charge the handset.
Severe noise interference.	<ul style="list-style-type: none"> • Keep the handset away from microwave ovens, computers, remote control toys, wireless microphones, alarm systems, intercoms, room monitors, fluorescent lights, and electrical appliances. • Move to another location or turn off the source of interference.
If you still have a problem.	<ul style="list-style-type: none"> • Call our customer hotline at 1-800-297-1023.

General Information

The TRU 346 complies with FCC Parts 15 and 68.

Operating Temperature: 0 °C to +50 °C (+32°F to +122 °F)

AC Adapter Information

AC Adapter part number: AD-312

Input Voltage: 120V AC 60Hz

Output Voltage: 9V DC 350 mA

Battery Information

Battery part number: BT-800

Capacity: 800 mAh, 3.6V

Battery Use Time (per charge)

From fully charged:

Talk Mode duration 6 hours

Standby Mode duration 10 days



If the handset is left off of the base, the actual Talk mode duration will be reduced respective to the amount of time the handset is off the base.

Recharge your phone on a regular basis about once a week by placing the handset on the base for 15-20 hours. When the operating time becomes short, even after the battery is recharged, please replace the battery. With normal usage, the battery should last about one year.

Replacement batteries may be purchased at your local Uniden dealer or by contacting the Uniden Parts Department (800) 554-3988. Hours are from 7:00 a.m. to 5:00 p.m. Central Time, Monday through Friday. We can also be reached on the web at www.uniden.com

Specifications, features, and availability of optional accessories are all subject to change without prior notice.

Technical Information

The FCC wants you to know!

Changes or modifications to this product not expressly approved by Uniden, or operation of this product in any way other than as detailed by the owner's manual, could void your authority to operate this product. The equipment cannot be used on public coin phone service provided by the telephone company. Connection to party line service is subject to state tariffs. (Contact the state public utility commission, public service commission or corporation commission for information.)

Below is some information that might concern you while using your new phone.

Range

Your new phone is designed to achieve the maximum possible range by transmitting and receiving according to the highest specifications set forth by the FCC. We have rated this phone to operate at a maximum distance with the qualification that the range depends upon the environment in which the telephone is used. Many factors limit range, and it would be impossible to include all the variables in our rating. The Maximum Range rating of this phone is meant to be used as a means of comparison against other range claims.

Telephone Line Problems

The FCC has granted the telephone company the right to disconnect service in the event that your phone causes problems on the telephone line. Also, the telephone company may make changes in facilities and services which may affect the operation of your unit. However, your telephone company must give adequate notice in writing prior to such actions to allow you time for making necessary arrangements to continue uninterrupted service.

If you are having trouble with your telephone service, you must first disconnect your phone to determine if it is the cause of your problem. If you determine that it is the cause, you must leave it disconnected until the trouble has been corrected.

Radio Interference

Radio interference may occasionally cause buzzing and humming in your cordless handset, or clicking noises in the base. This interference is caused by external sources such as TV, refrigerator, vacuum cleaner, fluorescent lighting, or electrical storm. Your unit is NOT DEFECTIVE. If these noises continue and are too distracting, please check around your home to see what appliances may be causing the problem.

In addition, we recommend that the base not be plugged into a circuit that also powers a major appliance because of the potential for interference. Be certain that the antenna on the unit is fully extended when needed.

In the unlikely event that you consistently hear other voices or distracting transmissions on your phone, you may be receiving radio signals from another cordless telephone or other source of interference. If you cannot eliminate this type of interference, you need to change to a different channel.

Finally, it should be noted that some cordless telephones operate at frequencies that may cause interference to nearby TVs and VCRs. To minimize or prevent such interference, the base of the cordless telephone should not be placed near or on top of a TV or VCR. If interference is experienced, moving the cordless telephone farther away from the TV or VCR will often reduce or eliminate the interference.

More Than One Cordless Telephone

If you want to use more than one cordless telephone in your home, they must operate on different channels. Press the channel key to select a channel that provides the clearest communication.

Cordless Telephone Privacy

Cordless telephones are radio devices. Communications between the handset and base of your cordless telephone are accomplished by means of radio waves which are broadcasted over the open airways. Because of the inherent physical properties of radio waves, your communications can be received by radio receiving devices other than your own cordless telephone unit. Consequently, any communications using your cordless telephone may not be private.

Index

A

Adjusting ringer and earpiece volume11

B

Battery pack

 Preparing and charging 9

 Replacement and handling 40

Beltclip installation..... 39

C

Caller ID

Caller ID service 28

 Call Waiting..... 36

 Deleting 32

 Setting Caller ID options 28

 Using..... 34

 Viewing 31

Connection 7

D

Dialing mode 8

Digital security code 4,38

E, F, G

Earpiece volume 11

H, I, J, K, L

Headset installation 39

Language29

M, N, O

Maintenance 40

Making a call 12

Memory dialing

 Erasing a stored name

 and phone number 26

 Making calls with memory dialing..... 21

 Storing phone numbers and names 17

P, Q

Package contents 5

Paging 27

R

Receiving a call 14

Redialing a call 15

Ringer tone and volume 11

S

Setting up the Base unit 6

Setting up the Handset 9

T, U, V, W, X, Y, Z

Technical information 44

Troubleshooting 41

At Uniden, we'll take care of you!

If you need any assistance with this product, please call our Customer Hotline at

1-800-297-1023

PLEASE DO NOT RETURN THIS PRODUCT TO THE PLACE OF PURCHASE.

Our Uniden representatives will be happy to help you with any matters regarding the operation of this unit, available accessories, or any other related matters.

Thank you for purchasing a Uniden product.
Hours: M-F 7:00 AM to 7:00 PM CST.

Memo

Memo

THANK YOU FOR PURCHASING A UNIDEN CORDLESS PHONE

A World Without Wires | **Uniden**[®]

Covered under one or more of the following U.S. patents:

4,511,761	4,523,058	4,595,795	4,797,916	5,381,460	5,426,690
5,434,905	5,491,745	5,533,010	5,574,727	5,650,790	5,660,269
5,661,780	5,663,981	5,671,248	5,717,312	5,754,407	5,768,345
5,787,356	5,838,721	5,864,619	5,893,034	5,912,968	5,915,227
5,929,598	5,930,720	5,960,358	5,987,330	6,044,281	6,070,082
6,125,277					

© 2001 Uniden America Corporation, Fort Worth, TX
All rights reserved.

Printed in China
UCZZ21724DZ